

产品特点 Feature

- 额定150A触点切换能力
150 amps continuous carry
- 满足异常工况应对要求, 能够切换10倍过电流
1500 amps interrupte under extreme condition
- 陶瓷钎焊密封技术, 电弧无泄漏, 产品不起火, 不爆炸
Hermetically sealed with hydrogen gas, the arc is not exposed. Be able to use in explosive & harsh environments without oxidation or contamination of contacts
- 采用陶瓷钎焊密封结构, 产品满足IP42防护等级
Contacts' part meet IP42 protection degree.
- 对安装方向不敏感, 可在任意方向安装
Not position sensitive- can be mounted in any position for ease of installation .
- 环保产品, 完全符合RoHS要求
RoHS compliant

触点参数表 Contact Data

项目 Item	说明 Information		
触点形式 Contact arrangement	1组常开触点 Power Contact:1 Form A		
额定负载电流 Current rating	150A		
接触电阻 Contact resistance	≤0.5mΩ (@6V 20A)		
最小适用负载 Min.Switching load	12VDC 1A		
最大切换电压 Max. Switching voltage	1000VDC		
最大分断电流 Max. Breaking current	1500A, 500VDC, 1次以上 1500A (500VDC, 1 cycle)		
最大切换功率 Max. Switching power	150KW		
电耐久性 (1) Electrical life ⁽¹⁾	阻性负载 Resistive load	500VDC 500V type	750VDC 750V type
		参照切换寿命折线图 Refer to the switchover life line chart	
	切换: 500次 (500VDC, -150A)		切换: 100次 (750VDC, -150A)
	500VDC, -150A 500 cycles		750VDC, -150A 100 cycles
容性负载 Capacitive load	接通: 7.5×10 ⁴ 次 (22.5VDC, τ=1ms, 冲击400A, 稳态150A)		接通: 7.5×10 ⁴ 次 (37.5VDC, τ=1ms, 冲击400A, 稳态150A)
	7.5×10 ⁴ cycles 22.5VDC, τ=1ms inrush 400A steady 150A		7.5×10 ⁴ cycles 37.5VDC, τ=1ms inrush 400A steady 150A
载流能力 (2) Load current capacity ⁽²⁾	参照耐受能力曲线图 Reference tolerance curve		

性能参数表 Parameters Table

项目 Item	说明 Information	
机械耐久性 Mechanical life	2×10 ⁵ 次 2×10 ⁵ cycles	
绝缘电阻 Insulation resistance	1000MΩ(1000VDC)	
介质耐压 Dielectric strength	触点间 Between open contacts	3000VAC 1min 1mA
	触点与线圈 Between contact and coil	3000VAC 1min 1mA
动作时间 (额定电压下) (at rated coil voltage)	≤30ms	
释放时间 (额定电压下) (at rated coil voltage)	≤10ms	
冲击 Shock resistance	稳定性 Functional	196m/s ² (20G)
	强度 Destructive	490m/s ² (50G)
振动 Vibration resistance	10Hz~500Hz 49m/s ² (5G)	
工作环境温度 Ambient temperature	-40°C~+85°C	
工作环境湿度 Ambient humidity	5%~95% RH	
重量 Weight	300g	
长×宽×高(mm) External dimension	75×40×67	

线圈规格表 CoilData⁽³⁾

额定电压 (VDC) Rated voltage (VDC)	工作电压 (VDC) Operation voltage (VDC)	最大电压 (VDC) Max. voltage (VDC)	动作电压 (VDC) Pick-up voltage (VDC)	释放电压 (VDC) Drop-out voltage (VDC)	线圈电阻(Ω) ±10% Coil resistance (±10%)(Ω)	启动功率 (W) Operating power (inrush, W)	稳态功率 (W) Operating power (stable, W)
12	12	16	≤9	≥1.0	24	6	6
24	24	32	≤18	≥2.0	96	6	6
48	48	64	≤36	≥4.0	384	6	6

备注:

NOTES:

- (1) 除特别标明外, 电耐久性测试环境温均为23°C, 通断比(on:off) 为0.6s: 5.4s.
Ambient temperature:23°C, L/R≤1ms.
- (2) 环境温度为23°C, 导线截面积≥45mm².
Ambient temperature:23°C, 45mm²conductor.
- (3) 如需其他额定电压, 可特殊订货。
Other types of rated voltage, please contact us.

参考数据 Reference date

带载切换寿命曲线图
Switching life

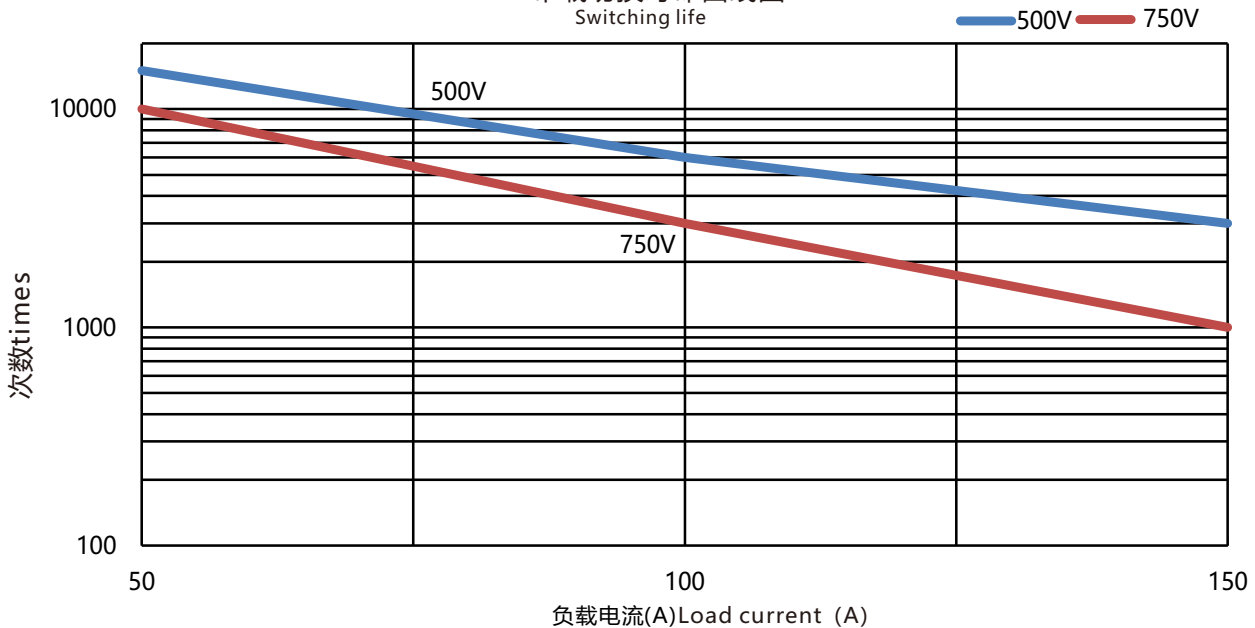

耐受能力曲线图
Tolerance curve

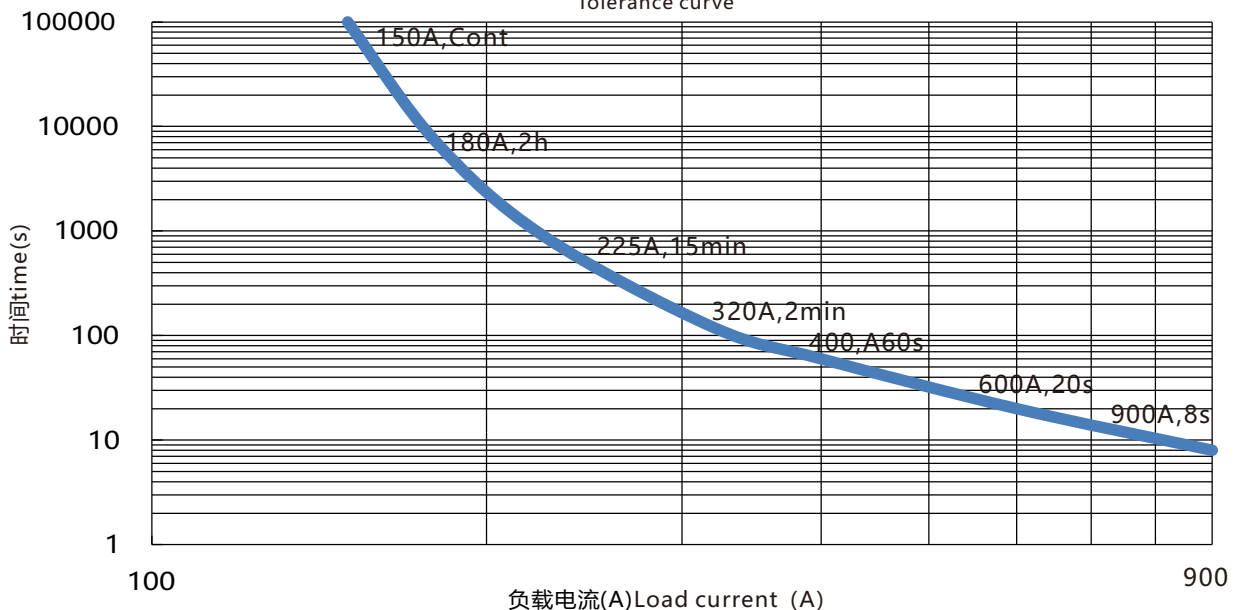

订货标记 Ordering Information

型号命名规则 Nomenclature

SES150C - □ **M** □ □ **2** □ □

客户特性号
Customer special code

无: 无客户特殊要求
Nil: No customer special requirement
数字或字母: 客户特殊要求,
与结构无关
Numbers or Letters: Customer special requirement

加固方式
Reinforce the way

1: 卡扣型
1: Card buckle type

负载连接方式
Load connection type

2: 内螺纹
2: internal thread

线圈端连接方式
Coil connection type

无: 带引出线
Nil: outgoing line
C: 引出线+连接器
C: outgoing line+connector

线圈电压
Coil voltage

12: 12VDC
24: 24VDC
48: 48VDC

触点组数
Contact arrangement

M: 1组常开触点
M: 1 Form A

负载电压
Voltage rating

750: 12~750VDC
500: 12~500VDC

负载电流
Load current

150C: 150A

基本型号
Type designation

SES

包装式样: 30PCS/箱
Packing style: 30pcs / box

外形尺寸 (卡扣型) Outline Dimensions(Card buckle type)

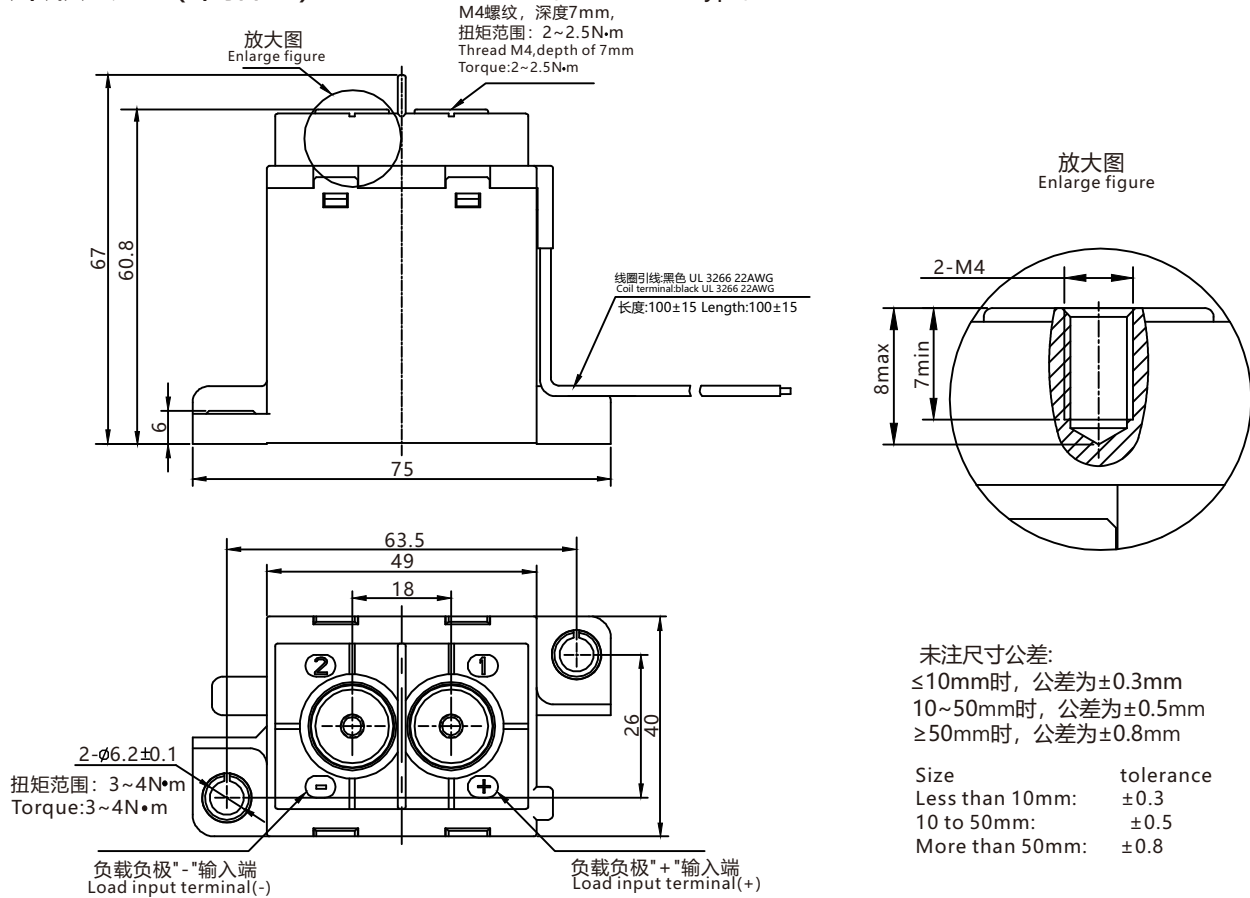

线圈端连接方式
Coil Connection Type

C: 引出线+连接器
C: Outgoing Line+Connector
二线片插头型号: 天海0435305或矢崎: 7283-1020
Connectors: Tian Hai :0435305 or Yazaki: 7283-1020

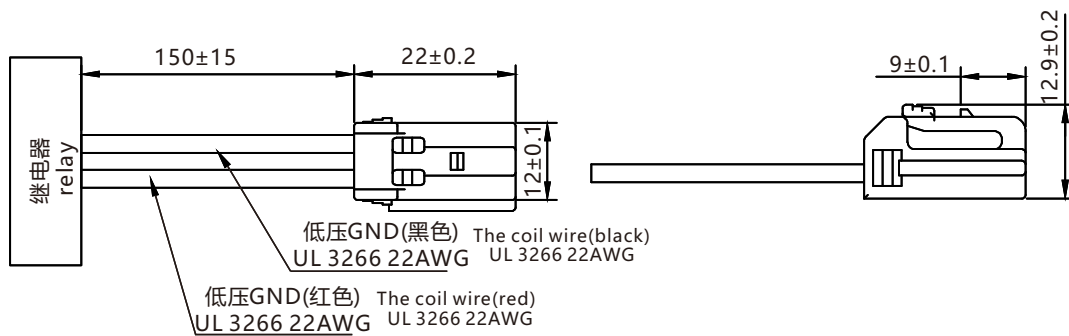

二线片插座型号: 天海0464705或矢崎: 7282-1020(不在包装盒中附带)
Connectors: Tian Hai :0464705 or Yazaki: 7282-1020(not included in the box)

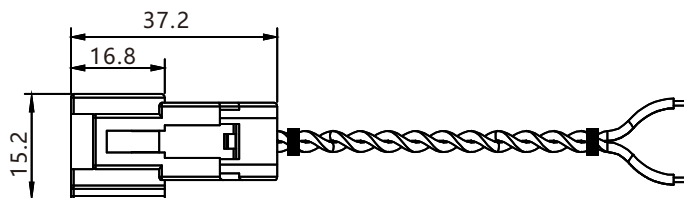

安装尺寸
Installation Size Chart

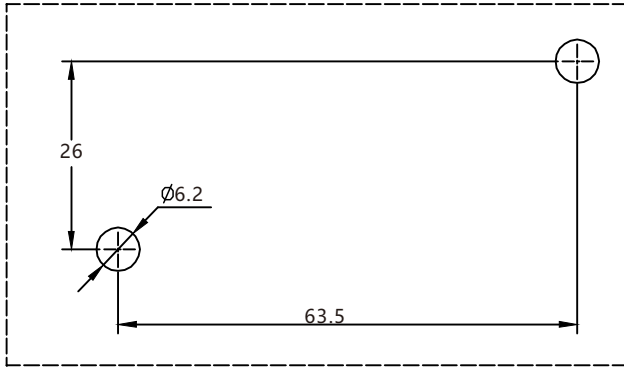

原理图
Schematic Diagram

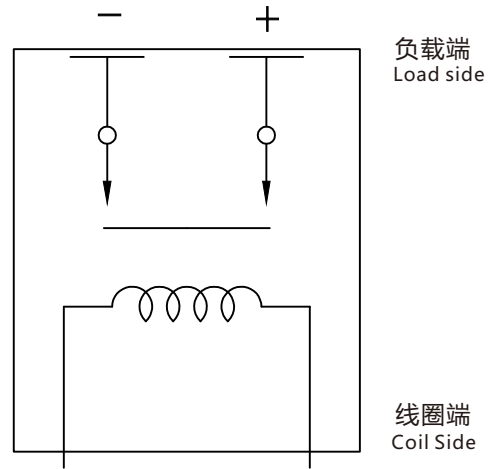

备注:负载端有极性,线圈端子无极性
NOTE:The contacts are polarized

说明:**NOTES:****●继电器安装注意事项****●Mounting Attention**

- 1.在继电器坠落的情况下，原则上请不要再使用；
In principle, please do not use it when the relay has fallen down.
- 2.本继电器的内部触点使用了气体保护，伴随着触点温度变化（环境温度+通电致使温度上升）而存在内部气体穿透，严禁将继电器长时间置于超过产品温度使用范围（-40℃~85℃）环境中；
The relay contacts are sealed and filled with gas. When the contact temperature changes, there is internal gas penetrating characteristic. SANYOU relays are forbidden to be used at the temperature beyond our suggestion -40℃~85℃ for long time.
- 3.在安装继电器时，一定要使用垫圈以防止螺丝松动；
When installing the relay, always use washers to prevent the screws from loosening.
- 4.在安装继电器时，锁紧继电器负载端扭力矩与安装孔扭力矩请控制在建议范围内，在超过范围的情况下，可能会造成端子滑牙或外壳破损，使用螺钉时，确保垫圈强度足够，否则会变形撑坏外壳；
Tighten each screw within the rated range given in the outline dimensions. Exceeding the maximum torque may result in breakage.
- 5.在安装继电器时，请不要靠近强磁场和发热源。
Avoid mounting the relay in strong magnetic fields (near a transformer or magnet) or close to an object that radiates heat.

●继电器负载端连接注意事项**●Electrical Life Attention**

- 1.请避免过度负载应用到产品上，如果超出额定范围，产品的性能无法保证；
This relay is a DC high-voltage switch. In its final breakdown mode, it may lose the ability to provide the proper cut-off. Therefore, do not exceed the indicated switching capacity and life.
- 2.请将继电器看做是有截止寿命的产品，不要超过开关的容量和使用寿命，为确保安全，应及时替换；
Please treat the relay as a product with limited life and replace it when necessary.
- 3.继电器的负载端子是有极性的，请按产品外表标示极性要求连接负载，否则产品性能无法保证；
The contacts of the relay are polarized. Please follow instructions in the connection schematic when connecting the contacts.
- 4.小心异物或油粘着在负载端子部分，这样可能导致负载端子散热异常，同时请按下表公称面积的连接导线或铜排。
Be careful that foreign matter and oils and fats kind, don't stick to the main terminal parts because it is likely to cause terminal parts to give off unusual heat. Also, please use the following specifications of conductor.

10A	公称截面积	≥2mm ²	Min. 2mm ² nominal cross-sectional area
20A	公称截面积	≥3mm ²	Min. 3mm ² nominal cross-sectional area
40A	公称截面积	≥10mm ²	Min. 10mm ² nominal cross-sectional area
60A	公称截面积	≥15mm ²	Min. 15mm ² nominal cross-sectional area
100A	公称截面积	≥35mm ²	Min. 35mm ² nominal cross-sectional area
150A	公称截面积	≥45mm ²	Min. 45mm ² nominal cross-sectional area
200A	公称截面积	≥60mm ²	Min. 60mm ² nominal cross-sectional area
250A	公称截面积	≥80mm ²	Min. 80mm ² nominal cross-sectional area
300A	公称截面积	≥100mm ²	Min. 100mm ² nominal cross-sectional area

●继电器线圈端连接注意事项**●Coil Attention**

1. 使用二极管吸收线圈反向电压时，会导致继电器释放时间延长，继电器负载切换性能下降，推荐使用可变电阻方式；
Please note that when using a diode, the switching speed may decrease and cause a reduction in cut-off performance, we recommend installing a surge protector varistor.
2. 在继电器使用时，考虑到使用环境温度和条件，继电器动作及释放电压将会变化，推荐使用额定电压给线圈供电以保证继电器正常工作；
The pick-up voltage and drop-out voltage will change with ambient temperature, please use rated voltage to make sure the relay operate reliable. Don't exceed maximum coil voltage.
3. 请勿持续在线圈上加最大电压；
Please do not continuously load the maximum voltage on the coil.
4. 带节能板的产品（200A及200A以上产品），推荐使用快速上升（阶跃供电方式）进行线圈驱动；
The 250A and 300A types have built-in dedicated drive circuit, please drive the coil with a quick startup (Built-in one-shot pulse generator circuit).
5. 带节能板的产品（200A及200A以上产品），在0.1s后产品进行线圈电流的自动切换，请不要在 < 0.1s 内重复切换线圈电压，否则产品性能不能保证。
After the ON signal enters the 250A and 300A types, automatic coil current switching occurs after approximately 0.1 seconds. Do not repeatedly turn it OFF within that 0.1seconds interval, as doing so may damage the relay.

声明:

本产品规格书仅供客户使用时参考，若有更改，恕不另行通知。

对三友而言，不可能评定继电器在每个具体应用领域的所有性能参数要求，因而客户应该根据具体的使用条件选择与之相匹配的产品，若有疑问，请与三友联系获取更多的技术支持。但产品选型责任仅由客户负责。

© 三友联众集团股份有限公司版权所有，本公司保留所有权利。

Disclaimer:

This datasheet is the customers' reference. All the specification are subject to change without notice.

We could not evaluate all the performance and parameters for every possible application. Thus the users should be in a right position to choose the suitable product for their own application. If there is any query, please contact Sanyou for technical service. However it is the users' responsibility to determine which product should be used only.

SANYOU CORPORATION LIMITED. All rights reserved by Sanyou.